

Vehicles & Trailers Available

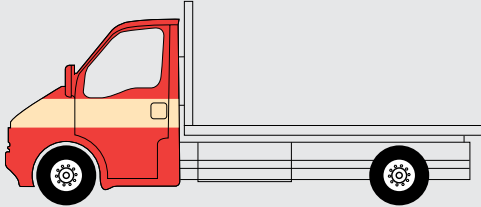

PICK UP

Payload: 1.5 tonne
Length: 12ft (3.7m)
GVW: 3.5 tonne

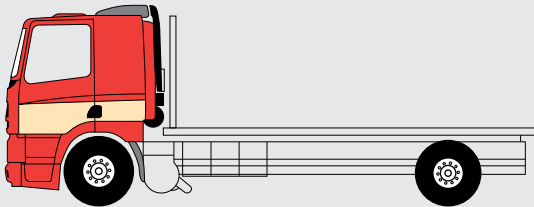

RIGID FLAT

Payload: 3.5 tonne
Length: 18ft (5.5m)
GVW: 7.5 tonne

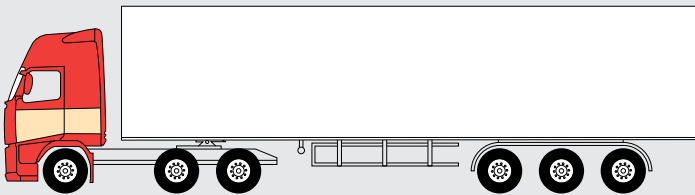

CURTAIN-SIDED TRAILER

Length: 40-45ft (12-13.75m)
GVW: 44 tonne

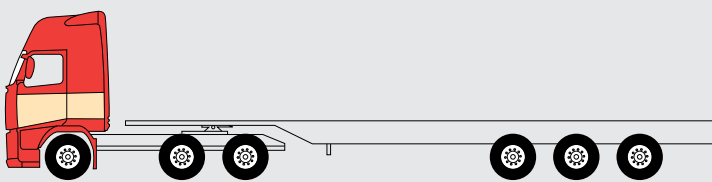

FLAT BED TRAILER

Length: 40-45ft (12-13.75m)
GVW: 44 tonne

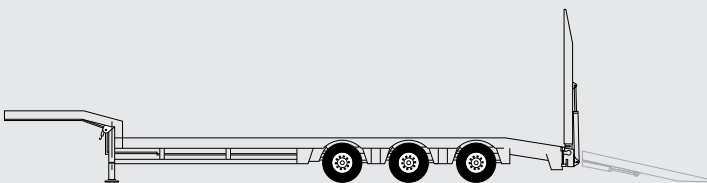

PLANT TRAILER

Payload: 35 tonne
Length: 29-48ft (8.8-14.6m)

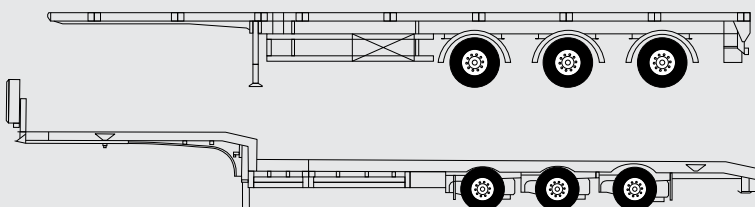

EXTENDABLE TRAILER

Payload: 50 tonne
Length: 24-85ft (7.3-26m)

EXTENDABLE 3 AXEL STEP-FRAME TRAILER WITH REAR MOUNTED CRANE

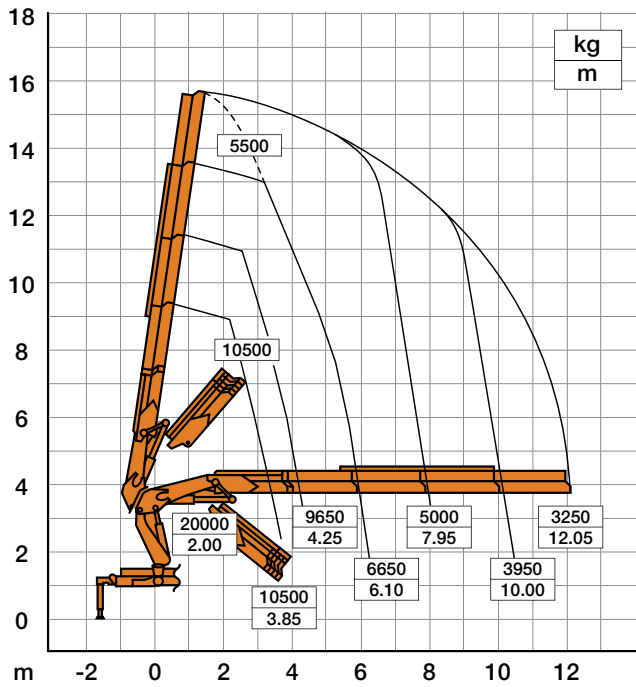

Length: 48ft
(14.6m)
Payload: 14 tonne

LIFT CAPACITIES kg							
RADIUS m	HEIGHT m						
	5.30	9.50	11.50	11.50	15.80	15.80	15.80
2.00	20000						
3.85		10500					
4.25			9650				
6.10				6650			
7.79					5000		
10.00						3950	
12.05							3250

The weights of any lifting attachments must be added to the weight to be lifted when determining the load

RIGID 3 AXEL VEHICLE WITH FORWARD MOUNTED CRANE

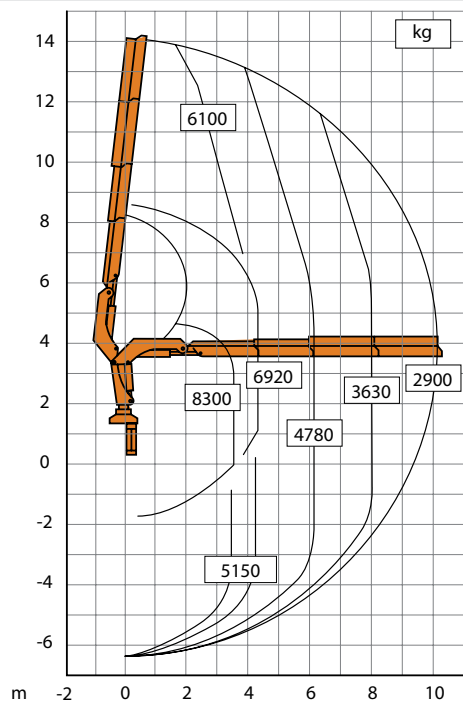

Payload: 10 tonne
Length: 26ft (8m)
GVW: 26 tonne

LIFT CAPACITIES kg			
RADIUS m	HEIGHT m		
	5.00	8.70	14.00
3.60	8300		
4.30		6920	6920
6.10			4780
8.00			3630
9.90			2900

The weights of any lifting attachments must be added to the weight to be lifted when determining the load

Walker and Son (Hauliers) Ltd

Ollerton Road, Tuxford,
Newark, Nottinghamshire
NG22 0PQ

Tel: 01777 870431

Fax: 01777 871855

www.walker-tuxford.co.uk